

American Standard (ANSI) MPB Steel Spur Gears

Pressure Angle 14 1/2°

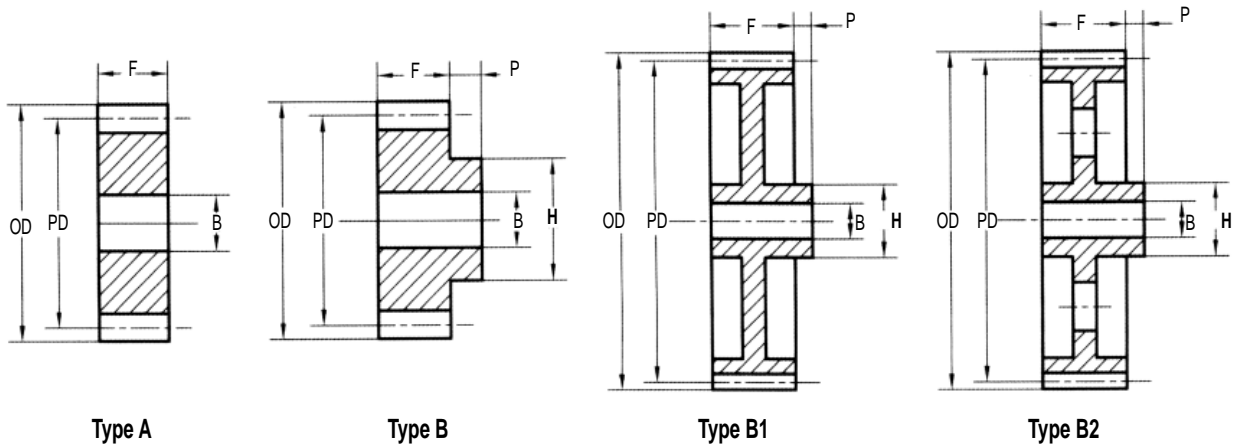

3 DP - 3" Face

Part No.	Diameter		Type	Hubs			Weight (Lbs)
	OD	PD		H	F + P	B	
S311	4.333	3.666	A	-	3	1-5/16	12.00
S312	4.666	4.000	A	-	3	1-5/16	11.00
S313	5.000	4.333	A	-	3	1-5/16	10.70
S314	5.333	4.667	A	-	3	1-5/16	12.80
S315	5.666	5.000	A	-	3	1-5/16	14.80
S316	6.000	5.333	A	-	3	1-5/16	17.00
S317	6.333	5.666	A	-	3	1-5/16	19.50
S318	6.666	6.000	A	-	3	1-5/16	22.00
S319	7.000	6.333	A	-	3	1-5/16	27.40
S320	7.333	6.667	A	-	3	1-7/16	30.70
S321	7.666	7.000	A	-	3	1-7/16	48.20
S322	8.000	7.333	A	-	3	1-7/16	55.00
S324	8.666	8.000	B	5 1/2	4 1/4	1-7/16	74.50
S325	9.000	8.333	B	5 1/2	4 1/4	1-7/16	83.60
S328	10.000	9.333	B	6 1/4	4 1/4	1-7/16	98.00
S330	10.666	10.000	B	6 1/4	4 1/4	1-9/16	114.00
S332	11.333	10.666	B	6 1/4	4 3/4	1-9/16	119.00
S336	12.666	12.000	B	6 1/2	4 3/4	1-9/16	106.00

4 DP - 2" Face

Part No.	Diameter		Type	Hubs			Weight (Lbs)
	OD	PD		H	F + P	B	
S411	3.250	2.750	B	2 1/4	2 7/8	1-1/8	4.00
S412	3.500	3.000	B	2 1/4	2 7/8	1-1/8	3.90
S413	3.750	3.250	B	2 1/4	2 7/8	1-1/8	4.60
S414	4.000	3.500	B	2 3/4	2 7/8	1-1/8	5.70
S415	4.250	3.750	B	3	2 7/8	1-1/8	6.80
S416	4.500	4.000	B	3 1/4	2 7/8	1-1/8	8.00
S417	4.750	4.250	B	3 1/2	2 7/8	1-1/8	9.20
S418	5.000	4.500	B	3 3/4	2 7/8	1-1/8	10.40
S419	5.250	4.750	B	4	2 7/8	1-1/8	10.50
S420	5.500	5.000	B	4 1/4	2 7/8	1-1/8	13.40
S421	5.750	5.250	B	4 1/2	2 7/8	1-1/8	14.90
S422	6.000	5.500	B	4 3/4	2 7/8	1-1/8	16.50
S424	6.500	6.000	B	4 3/4	3 1/2	1-1/8	22.80
S426	7.000	6.500	B	4 3/4	3 1/2	1-1/8	24.80
S428	7.500	7.000	B	4 3/4	3 1/2	1-1/8	27.80
S430	8.000	7.500	B	4 3/4	3 1/2	1-1/4	31.00
S432	8.500	8.000	B	4 3/4	3 1/2	1-1/4	34.40
S436	9.500	9.000	B	4 3/4	3 1/2	1-1/4	41.70
S440	10.500	10.000	B	5 1/8	3 1/2	1-1/4	51.80
S442	11.000	10.500	B	5 1/8	3 1/2	1-1/4	56.00
S444	11.500	11.000	B	5 1/8	3 1/2	1-1/4	60.80
S445	-	-	-	-	-	1-1/4	-
S448	12.500	12.000	B	5 1/8	3 1/2	1-1/4	70.80

Sample Part:
S311
S = Steel
3 = Diametral Pitch
11 = No. Teeth

Bored to Size Gears
 Available in Standard ANSI
 or Metric (ISO) Bores,
 Keyways and (2) Setscrews

American Standard (ANSI) MPB Steel Spur Gears

Pressure Angle 14½°

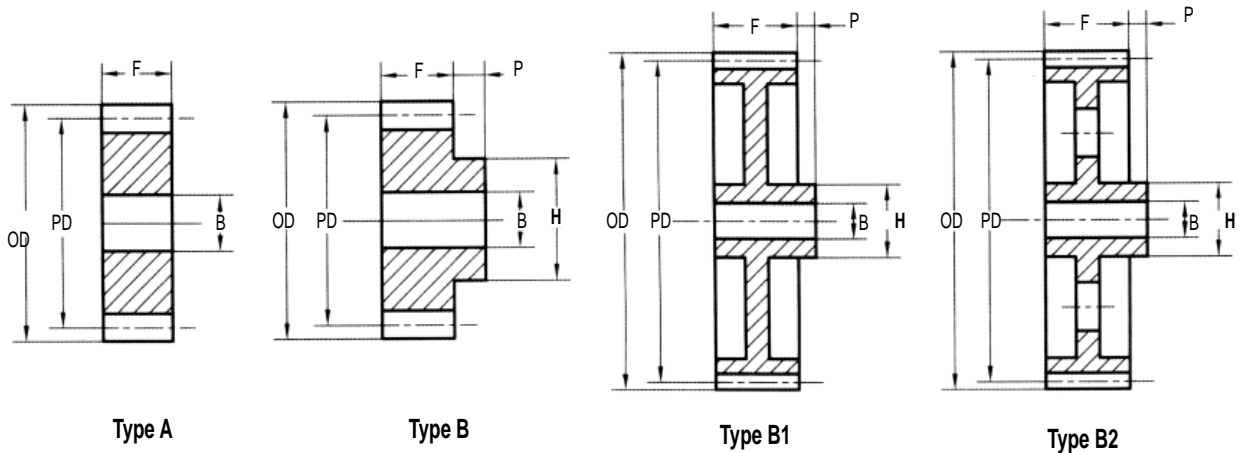

5 DP - 1 3/4" Face

Part No.	Diameter		Type	Hubs			Weight (Lbs)
	OD	PD		H	F + P	B	
S511	2.600	2.200	B	1 25/32	2 5/8	1-1/16	2.00
S512	2.800	2.400	B	1 25/32	2 5/8	1-1/16	2.00
S513	3.000	2.600	B	2	2 5/8	1-1/16	2.60
S514	3.200	2.800	B	2 3/16	2 5/8	1-1/16	3.10
S515	3.400	3.000	B	2 3/8	2 5/8	1-1/16	3.70
S516	3.600	3.200	B	2 19/32	2 5/8	1-1/16	4.50
S517	3.800	3.400	B	2 7/8	2 5/8	1-1/16	5.20
S518	4.000	3.600	B	3	2 5/8	1-1/16	5.90
S519	4.200	3.800	B	3 1/4	2 5/8	1-1/16	6.70
S520	4.400	4.000	B	3 3/8	2 5/8	1-1/16	7.50
S521	4.600	4.200	B	3 3/8	2 5/8	1-1/16	8.10
S522	4.800	4.400	B	3 3/8	2 5/8	1-1/16	8.80
S523	5.000	4.600	B	3 3/8	2 5/8	1-1/16	9.50
S524	5.200	4.800	B	3 3/8	3	1-1/16	11.00
S525	5.400	5.000	B	3 3/8	3	1-1/16	11.80
S526	5.600	5.200	B	3 3/8	3	1-1/16	12.90
S527	5.800	5.400	B	3 3/8	3	1-1/16	13.50
S528	6.000	5.600	B	3 3/8	3	1-1/16	14.30
S530	6.400	6.000	B	3 3/8	3	1-1/16	16.00
S532	6.800	6.400	B	4 1/4	3	1-1/16	18.00
S533	7.000	6.600	B	4 1/4	3	1-1/16	19.50
S535	7.400	7.000	B	4 1/4	3	1-3/16	22.80
S536	7.600	7.200	B	4 1/4	3	1-3/16	25.30
S539	8.200	7.800	B	4 1/4	3	1-3/16	26.90
S540	8.400	8.000	B	4 1/4	3	1-3/16	28.50
S542	8.800	8.400	B	4 5/8	3	1-3/16	33.00
S545	9.400	9.000	B	4 5/8	3	1-3/16	35.00
S548	10.000	9.500	B	4 3/4	3	1-3/16	39.50
S550	10.400	10.000	B	4 3/4	3	1-3/16	43.60
S552	10.800	10.400	B	4 3/4	3	1-3/16	46.70
S554	11.200	10.800	B	4 3/4	3	1-3/16	49.30
S555	11.400	11.000	B	4 3/4	3	1-3/16	52.00
S558	12.000	11.600	B	4 3/4	3	1-3/16	56.10
S560	12.400	12.000	B	4 3/4	3	1-3/16	60.90
S564	13.200	12.800	B	4 3/4	3	1-3/16	70.50
S570	14.400	14.000	B2	5	3	1-3/16	48.40
S580	16.400	16.000	B2	5	3	1-3/16	57.00

6 DP - 1 1/2" Face

Part No.	Diameter		Type	Hubs			Weight (Lbs)
	OD	PD		H	F + P	B	
S611	2.166	1.833	B	1 1/2	2 3/8	1	1.10
S612	2.333	2.000	B	1 1/2	2 3/8	1	1.10
S613	2.500	2.167	B	1 3/4	2 3/8	1	1.50
S614	2.666	2.333	B	1 13/16	2 3/8	1	1.80
S615	2.833	2.500	B	2	2 3/8	1	2.20
S616	3.000	2.666	B	2 5/32	2 3/8	1	2.60
S617	3.167	2.833	B	2 7/16	2 3/8	1	2.90
S618	3.333	3.000	B	2 1/2	2 3/8	1	3.50
S619	3.500	3.167	B	2 3/4	2 3/8	1	3.90
S620	3.666	3.333	B	2 27/32	2 3/8	1	4.60
S621	3.833	3.500	B	3	2 3/8	1	5.10
S622	4.000	3.666	B	3	2 3/8	1-1/8	5.50
S623	4.167	3.823	B	3	2 1/2	1-1/8	5.90
S624	4.333	4.000	B	3	2 1/2	1-1/8	6.50
S625	4.500	4.167	B	3	2 1/2	1-1/8	6.50
S626	4.666	4.330	B	3	2 1/2	1-1/8	6.80
S627	4.833	4.500	B	3	2 1/2	1-1/8	7.60
S628	5.000	4.666	B	3	2 1/2	1-1/8	8.30
S630	5.333	5.000	B	3 1/8	2 1/2	1-1/8	9.50
S632	5.666	5.333	B	3 1/8	2 1/2	1-1/8	10.70
S633	5.833	5.500	B	3 1/4	2 1/2	1-1/8	11.30
S635	6.167	5.833	B	3 1/4	2 1/2	1-1/8	12.20
S636	6.333	6.000	B	3 1/4	2 1/2	1-1/8	13.30
S639	6.833	6.500	B	4	2 1/2	1-1/8	16.60
S640	7.000	6.666	B	4	2 1/2	1-1/8	17.60
S642	7.333	7.000	B	4	2 1/2	1-1/8	18.90
S645	7.833	7.500	B	4	2 1/2	1-1/8	21.30
S648	8.333	8.000	B	4 1/8	2 1/2	1-1/8	24.30
S650	8.666	8.333	B	4 1/4	2 1/2	1-1/8	25.80
S652	9.000	8.666	B	4 1/4	2 1/2	1-1/8	27.90
S654	9.333	9.000	B	4 1/8	2 1/2	1-1/8	30.40
S655	9.500	9.166	B	4 3/8	2 1/2	1-1/8	31.80
S658	10.000	9.666	B	4 3/8	2 1/2	1-1/8	33.90
S660	10.333	10.000	B	4 3/8	2 3/4	1-1/4	34.30
S664	11.000	10.666	B	4 3/8	2 3/4	1-1/4	42.20
S666	11.333	11.000	B	4 3/8	2 3/4	1-1/4	50.00
S672	12.333	12.000	B	4 3/8	2 3/4	1-1/4	53.00

Sample Part:

S511

S = Steel

5 = Diametral Pitch

11 = No. Teeth

Bored to Size Gears
Available in Standard ANSI
or Metric (ISO) Bores,
Keyways and (2) Setscrews

American Standard (ANSI) MPB Steel Spur Gears

Pressure Angle 14½°

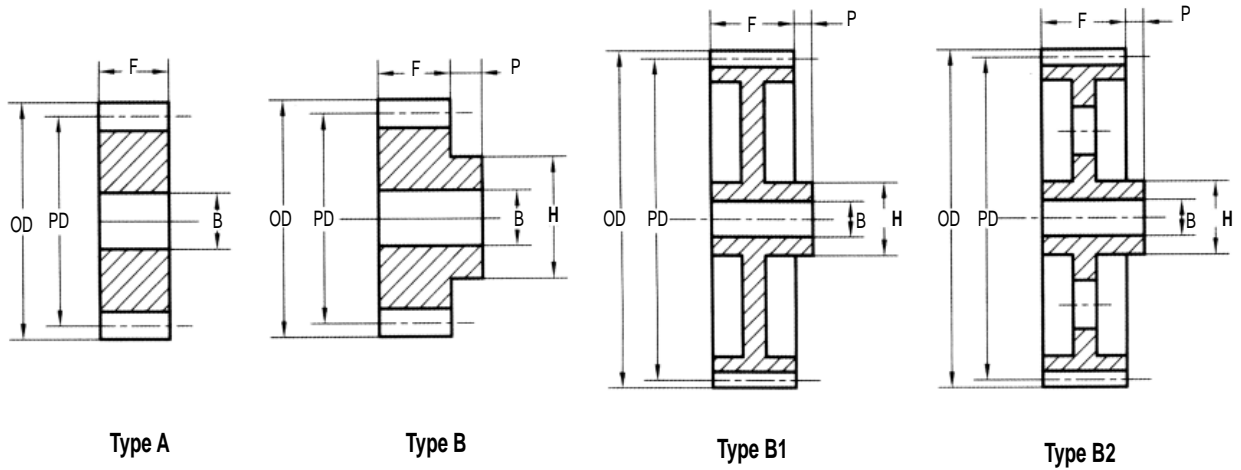

8 DP - 1 1/4" Face

Part No.	Diameter		Type	Hubs			Weight (Lbs)
	OD	PD		H	F + P	B	
S811	1.625	1.375	B	1 1/8	2	3/4	0.50
S812	1.750	1.500	B	1 1/8	2	3/4	0.50
S813	1.875	1.625	B	1 1/4	2	3/4	0.70
S814	2.000	1.750	B	1 3/8	2	3/4	0.90
S815	2.125	1.875	B	1 1/2	2	7/8	0.90
S816	2.250	2.000	B	1 5/8	2	7/8	1.10
S817	2.375	2.125	B	1 3/4	2	7/8	1.30
S818	2.500	2.250	B	1 7/8	2	7/8	1.60
S819	2.625	2.375	B	2	2	7/8	1.80
S820	2.750	2.500	B	2 1/8	2	7/8	2.00
S821	2.875	2.625	B	2 1/4	2	7/8	2.30
S822	3.000	2.750	B	2 3/8	2	7/8	2.60
S824	3.250	3.000	B	2 5/8	2 1/4	7/8	3.60
S825	3.375	3.125	B	2 5/8	2 1/4	7/8	3.80
S826	3.500	3.250	B	2 5/8	2 1/4	7/8	3.90
S828	3.750	3.500	B	2 5/8	2 1/4	7/8	4.40
S830	4.000	3.750	B	2 3/4	2 1/4	7/8	5.10
S832	4.250	4.000	B	2 7/8	2 1/4	1	5.60
S835	4.625	4.375	B	3	2 1/4	1	6.20
S836	4.750	4.500	B	3	2 1/4	1	7.00
S838	5.000	4.750	B	3	2 1/4	1	7.80
S840	5.250	5.000	B	3	2 1/4	1	8.30
S842	5.500	5.250	B	3	2 1/4	1	9.00
S844	5.750	5.500	B	3	2 1/4	1	9.70
S845	6.000	5.750	B	3	2 1/4	1	10.30
S848	6.250	6.000	B	3	2 1/4	1	11.30

10 DP - 1" Face

Part No.	Diameter		Type	Hubs			Weight (Lbs)
	OD	PD		H	F + P	B	
S1011	1.300	1.100	B	15/16	1 5/8	5/8	0.30
S1012	1.400	1.200	B	15/16	1 5/8	5/8	0.30
S1013	1.500	1.300	B	1	1 5/8	5/8	0.30
S1014	1.600	1.400	B	1 1/8	1 5/8	5/8	0.40
S1015	1.700	1.500	B	1 7/32	1 5/8	5/8	0.50
S1016	1.800	1.600	B	1 5/16	1 5/8	3/4	0.60
S1017	1.900	1.700	B	1 3/8	1 5/8	3/4	0.60
S1018	2.000	1.800	B	1 17/32	1 5/8	3/4	0.80
S1019	2.100	1.900	B	1 9/16	1 5/8	3/4	0.90
S1020	2.200	2.000	B	1 23/32	1 5/8	3/4	1.00
S1021	2.300	2.100	B	1 3/4	1 5/8	3/4	1.20
S1022	2.400	2.200	B	1 7/8	1 5/8	3/4	1.30
S1024	2.600	2.400	B	2 1/8	1 5/8	3/4	1.60
S1025	2.700	2.500	B	2 1/8	1 5/8	3/4	1.80
S1026	2.800	2.600	B	2 1/8	1 5/8	3/4	1.90
S1028	3.000	2.800	B	2 1/8	1 7/8	3/4	2.30
S1030	3.200	3.000	B	2 1/8	1 7/8	3/4	2.60
S1032	3.400	3.200	B	2 1/8	1 7/8	3/4	2.90
S1035	3.700	3.500	B	2 1/4	1 7/8	3/4	3.40
S1036	3.800	3.600	B	2 1/4	1 7/8	3/4	3.50
S1038	4.000	3.800	B	2 1/4	1 7/8	3/4	3.80
S1040	4.200	4.000	B	2 1/4	1 7/8	7/8	4.10
S1042	4.400	4.200	B	2 1/4	1 7/8	7/8	4.50
S1044	4.600	4.400	B	2 1/2	1 7/8	7/8	5.00
S1045	4.700	4.500	B	2 1/2	1 7/8	7/8	5.30
S1048	5.000	4.800	B	2 1/2	1 7/8	7/8	5.90
S1050	5.200	5.000	B	2 1/2	1 7/8	7/8	6.40
S1054	5.600	5.400	B	2 1/2	1 7/8	7/8	7.80
S1055	5.700	5.500	B	2 1/2	1 7/8	7/8	7.90
S1060	6.200	6.000	B	2 1/2	1 7/8	7/8	8.70

Sample Part:
S811
S = Steel
8 = Diametral Pitch
11 = No. Teeth

Bored to Size Gears
 Available in Standard ANSI
 or Metric (ISO) Bores,
 Keyways and (2) Setscrews

American Standard (ANSI) MPB Steel Spur Gears

Pressure Angle 14 1/2°

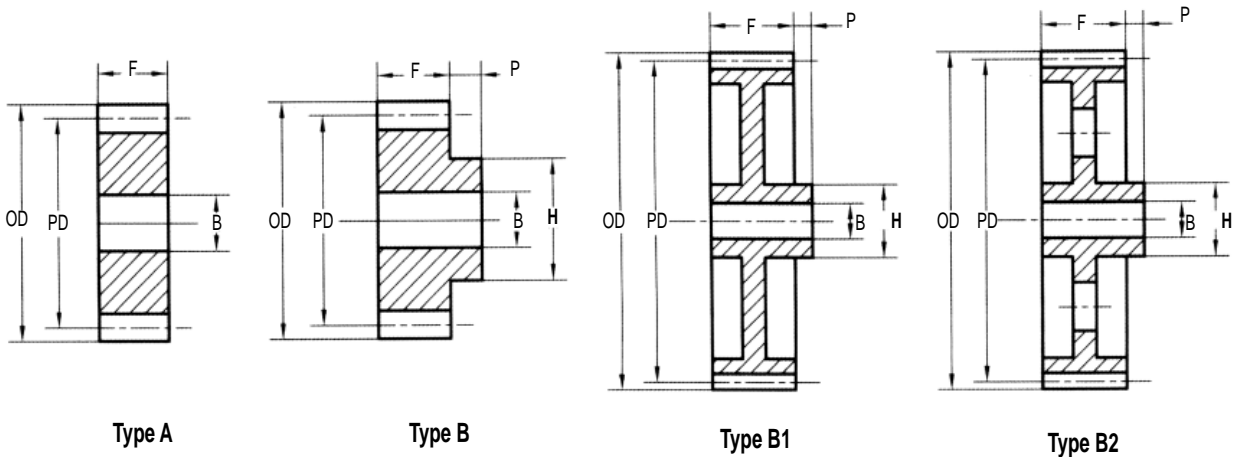

12 DP - 3/4" Face

Part No.	Diameter		Type	Hubs			Weight (Lbs)
	OD	PD		H	F + P	B	
S1211	1.083	0.917	B	3/4	1 1/4	1/2	0.14
S1212	1.167	1.000	B	3/4	1 1/4	1/2	0.16
S1213	1.250	1.083	B	13/16	1 1/4	1/2	0.20
S1214	1.333	1.167	B	29/32	1 1/4	1/2	0.24
S1215	1.417	1.250	B	1	1 3/8	5/8	0.27
S1216	1.500	1.333	B	1 1/6	1 3/8	5/8	0.34
S1217	1.580	1.413	B	1 1/8	1 3/8	5/8	0.36
S1218	1.667	1.500	B	1 1/4	1 3/8	5/8	0.42
S1219	1.750	1.583	B	1 5/16	1 3/8	5/8	0.48
S1220	1.833	1.667	B	1 13/32	1 3/8	5/8	0.56
S1221	1.917	1.750	B	1 1/2	1 3/8	5/8	0.64
S1222	2.000	1.833	B	1 9/16	1 3/8	5/8	0.70
S1223	2.083	1.917	B	1 5/8	1 3/8	5/8	0.78
S1224	2.166	2.000	B	1 3/4	1 3/8	5/8	0.88
S1225	2.250	2.083	B	1 27/32	1 3/8	5/8	0.96
S1226	2.333	2.167	B	1 15/16	1 3/8	5/8	1.14
S1228	2.500	2.333	B	2 1/16	1 3/8	5/8	1.34
S1230	2.667	2.500	B	2 1/4	1 3/8	5/8	1.60
S1232	2.833	2.667	B	2 1/4	1 3/8	5/8	1.72
S1234	3.000	2.833	B	2 1/4	1 3/8	5/8	1.88
S1236	3.167	3.000	B	2 1/2	1 3/8	5/8	2.20
S1238	3.333	3.167	B	2 1/2	1 3/8	5/8	2.38
S1240	3.500	3.333	B	2 1/2	1 3/8	5/8	2.54
S1242	3.666	3.500	B	2 1/2	1 3/8	5/8	2.72
S1244	3.833	3.667	B	2 1/2	1 3/8	5/8	2.94
S1248	4.166	4.000	B	2 1/2	1 3/8	5/8	3.50
S1252	4.500	4.333	B	2 3/4	1 1/2	5/8	3.90
S1254	4.666	4.500	B	2 3/4	1 1/2	3/4	4.40
S1256	4.833	4.667	B	2 3/4	1 1/2	3/4	4.60
S1260	5.166	5.000	B	2 3/4	1 1/2	3/4	5.14
S1264	5.500	5.333	B	2 3/4	1 1/2	3/4	5.74
S1266	5.665	5.500	B	2 3/4	1 1/2	3/4	6.02
S1268	5.830	5.665	B	2 3/4	1 1/2	3/4	6.60
S1272	6.166	6.000	B	2 3/4	1 1/2	3/4	7.02

16 DP - 1/2" Face

Part No.	Diameter		Type	Hubs			Weight (Lbs)
	OD	PD		H	F + P	B	
S1611	0.813	0.687	B	9/16	15/16	3/8	0.06
S1612	0.875	0.750	B	9/16	15/16	3/8	0.06
S1613	0.937	0.812	B	5/8	15/16	3/8	0.08
S1614	1.000	0.875	B	11/16	15/16	3/8	0.08
S1615	1.062	0.937	B	3/4	15/16	1/2	0.10
S1616	1.125	1.000	B	13/16	15/16	1/2	0.12
S1617	1.187	1.062	B	7/8	15/16	1/2	0.14
S1618	1.250	1.125	B	15/16	15/16	1/2	0.16
S1619	1.312	1.187	B	1	15/16	1/2	0.20
S1620	1.375	1.250	B	1 1/16	15/16	1/2	0.22
S1621	1.438	1.312	B	1 1/8	15/16	1/2	0.24
S1622	1.500	1.375	B	1 3/16	15/16	1/2	0.28
S1623	1.562	1.437	B	1 1/4	15/16	1/2	0.32
S1624	1.625	1.500	B	1 5/16	15/16	1/2	0.34
S1625	1.688	1.562	B	1 3/8	15/16	1/2	0.42
S1626	1.750	1.625	B	1 7/16	15/16	1/2	0.49
S1628	1.875	1.750	B	1 1/2	1	1/2	0.52
S1630	2.000	1.875	B	1 5/8	1	1/2	0.60
S1632	2.125	2.000	B	1 3/4	1	1/2	0.70
S1634	2.250	2.125	B	1 7/8	1	1/2	0.80
S1636	2.375	2.250	B	2	1	1/2	0.92
S1638	2.500	2.375	B	2	1	1/2	0.98
S1640	2.626	2.500	B	2	1	1/2	1.10
S1642	2.750	2.626	B	2	1	1/2	1.20
S1644	2.875	2.750	B	2	1	1/2	1.30
S1648	3.125	3.000	B	2	1	1/2	1.40
S1652	3.375	3.250	B	2	1	1/2	1.50
S1654	3.500	3.375	B	2	1	1/2	1.60
S1656	3.625	3.500	B	2	1	1/2	1.70
S1660	3.875	3.750	B	2	1	1/2	1.90
S1664	4.125	4.000	B	2	1 1/8	5/8	2.20
S1666	4.250	4.125	B	2 1/4	1 1/8	5/8	2.50
S1668	4.375	4.250	B	2 1/4	1 1/8	5/8	2.70
S1672	4.625	4.500	B	2 1/4	1 1/8	5/8	2.80
S1680	5.125	5.000	B	2 1/4	1 1/8	5/8	3.40
S1684	5.375	5.250	B	2 1/4	1 1/8	5/8	3.60
S1688	5.625	5.500	B	2 1/4	1 1/8	5/8	3.90
S1696	6.125	6.000	B	2 1/4	1 1/8	5/8	4.60
S16102	-	-	-	-	-	5/8	-

Sample Part:

S1211

S = Steel

12 = Diametral Pitch

11 = No. Teeth

Bored to Size Gears
Available in Standard ANSI
or Metric (ISO) Bores,
Keyways and (2) Setscrews

American Standard (ANSI) MPB Steel Spur Gears

Pressure Angle 14½°

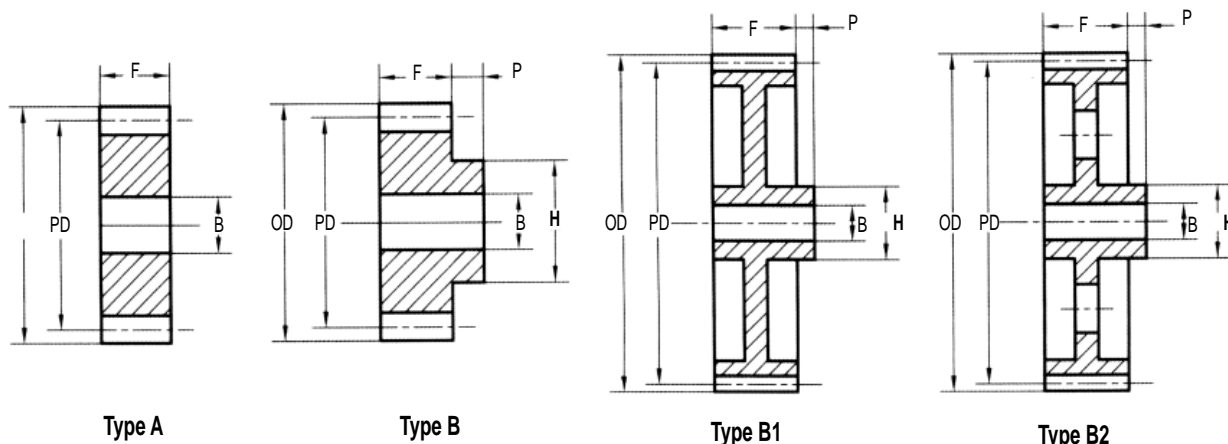

20 DP - 3/8" Face

Part No.	Diameter		Type	Hubs			Weight (Lbs)
	OD	PD		H	F + P	B	
S2011	0.650	0.550	B	15/32	3/4	5/16	0.02
S2012	0.700	0.600	B	15/32	3/4	5/16	0.02
S2013	0.750	0.650	B	1/2	3/4	5/16	0.04
S2014	0.800	0.700	B	35/64	3/4	5/16	0.04
S2015	0.850	0.750	B	39/64	3/4	3/8	0.04
S2016	0.900	0.800	B	21/32	3/4	3/8	0.04
S2017	0.950	0.850	B	45/64	3/4	3/8	0.08
S2018	1.000	0.900	B	3/4	3/4	3/8	0.08
S2019	1.050	0.950	B	51/64	3/4	3/8	0.10
S2020	1.100	1.000	B	55/64	3/4	3/8	0.12
S2021	1.150	1.050	B	7/8	3/4	3/8	0.12
S2022	1.200	1.100	B	31/32	3/4	3/8	0.14
S2023	1.250	1.150	B	31/32	3/4	3/8	0.16
S2024	1.300	1.200	B	1 1/16	3/4	3/8	0.19
S2025	1.350	1.250	B	1 17/64	3/4	3/8	0.20
S2026	1.400	1.300	B	1 17/64	3/4	3/8	0.22
S2027	1.450	1.350	B	1 1/4	3/4	3/8	0.24
S2028	1.500	1.400	B	1 5/16	3/4	3/8	0.26
S2030	1.600	1.500	B	1 23/64	3/4	3/8	0.30
S2032	1.700	1.600	B	1 7/16	7/8	3/8	0.40
S2033	1.750	1.650	B	1 5/8	7/8	3/8	0.45
S2035	1.850	1.750	B	1 9/16	7/8	3/8	0.50
S2036	1.900	1.800	B	1 5/8	7/8	3/8	0.52
S2040	2.100	2.000	B	1 13/16	7/8	3/8	0.64
S2042	2.200	2.100	B	2	7/8	3/8	0.70
S2044	2.300	2.200	B	2	7/8	3/8	0.73
S2045	2.350	2.250	B	2	7/8	3/8	0.82
S2048	2.500	2.400	B	2	7/8	3/8	0.88
S2050	2.600	2.500	B	2	7/8	3/8	0.90
S2054	2.800	2.700	B	2	7/8	3/8	0.95
S2055	2.850	2.750	B	2	7/8	3/8	1.04
S2056	2.900	2.800	B	2	7/8	3/8	1.10
S2060	3.100	3.000	B	2	7/8	3/8	1.16
S2064	3.300	3.200	B	2	7/8	3/8	1.26
S2066	3.400	3.300	B	2	7/8	3/8	1.32
S2068	-	-	B	2	7/8	3/8	-
S2070	3.600	3.500	B	2	7/8	3/8	1.40
S2072	3.700	3.600	B	2-1/4	7/8	3/8	1.60
S2075	3.850	3.750	B	2-1/4	7/8	3/8	1.70
S2080	4.100	4.000	B	2-1/4	7/8	1/2	1.82
S2084	4.300	4.200	B	2-1/4	7/8	1/2	1.96
S2090	4.600	4.500	B	2-1/4	7/8	1/2	2.20
S2096	4.900	4.800	B	2-1/4	7/8	1/2	2.42
S20100	5.100	5.000	B	2-1/4	7/8	1/2	2.60
S20112	5.700	5.600	B	1-3/4	7/8	1/2	2.86
S20120	6.100	6.000	B	1-3/4	7/8	1/2	3.24
S20132	6.700	6.600	B	1-3/4	7/8	1/2	3.80

24 DP - 1/4" Face

Part No.	Diameter		Type	Hubs			Weight (Lbs)
	OD	PD		H	F + P	B	
S2411	0.542	0.458	B	3/8	9/16	1/4	0.02
S2412	0.583	0.500	B	3/8	9/16	1/4	0.02
S2413	0.625	0.542	B	7/16	9/16	1/4	0.03
S2414	0.666	0.583	B	15/32	9/16	1/4	0.04
S2415	0.708	0.625	B	1/2	9/16	1/4	0.04
S2416	0.750	0.666	B	35/64	9/16	5/16	0.04
S2417	0.791	0.709	B	9/16	9/16	5/16	0.04
S2418	0.833	0.750	B	5/8	9/16	5/16	0.04
S2419	0.875	0.791	B	5/8	9/16	5/16	0.06
S2420	0.917	0.833	B	23/32	9/16	5/16	0.06
S2421	0.959	0.875	B	3/4	9/16	3/8	0.06
S2422	1.000	0.917	B	3/4	9/16	3/8	0.06
S2423	1.042	0.959	B	13/16	5/8	3/8	0.08
S2424	1.083	1.000	B	7/8	5/8	3/8	0.10
S2425	1.125	1.042	B	7/8	5/8	3/8	0.10
S2426	1.166	1.083	B	7/8	5/8	3/8	0.10
S2427	1.208	1.125	B	7/8	5/8	3/8	0.12
S2428	1.250	1.166	B	1	5/8	3/8	0.14
S2430	1.333	1.250	B	1	5/8	3/8	0.16
S2432	1.416	1.333	B	1 1/8	5/8	3/8	0.18
S2433	1.458	1.375	B	1 1/8	5/8	3/8	0.20
S2435	1.541	1.458	B	1 1/8	5/8	3/8	0.20
S2436	1.583	1.500	B	1 1/8	5/8	3/8	0.20
S2439	-	-	-	-	-	3/8	-
S2440	1.750	1.666	B	1 1/8	5/8	3/8	0.24
S2442	1.833	1.750	B	1 1/4	5/8	3/8	0.28
S2444	1.917	1.833	B	1 1/4	5/8	3/8	0.30
S2445	1.959	1.875	B	1 1/4	5/8	3/8	0.30
S2448	2.083	2.000	B	1 1/4	5/8	3/8	0.32
S2450	2.166	2.083	B	1 1/4	5/8	3/8	0.35
S2454	2.333	2.250	B	1 1/4	5/8	3/8	0.38
S2455	2.374	2.291	B	1 1/4	5/8	3/8	0.39
S2456	2.416	2.333	B	1 1/4	5/8	3/8	0.40
S2460	2.583	2.500	B	1 1/4	5/8	3/8	0.46
S2464	2.749	2.666	B	1 1/4	5/8	3/8	0.49
S2466	2.833	2.750	B	1 1/4	5/8	3/8	0.52
S2470	3.000	2.917	B	1 3/8	3/4	3/8	0.58
S2472	3.083	3.000	B	1 3/8	3/4	1/2	0.64
S2484	3.583	3.500	B	1 1/2	3/4	1/2	0.88
S2496	4.083	4.000	B	1 1/2	3/4	1/2	1.08
S24120	5.083	5.000	B	1 1/2	3/4	1/2	2.60
S24144	6.083	6.000	B	1 5/8	27/32	1/2	2.28

American Standard (ANSI) MPB Cast Iron Spur Gears

Pressure Angle 14 1/2°

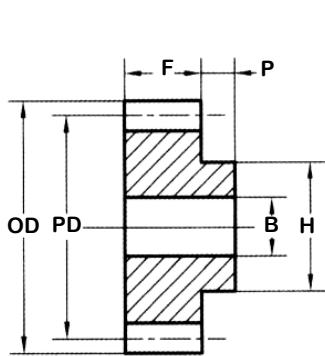

Type B

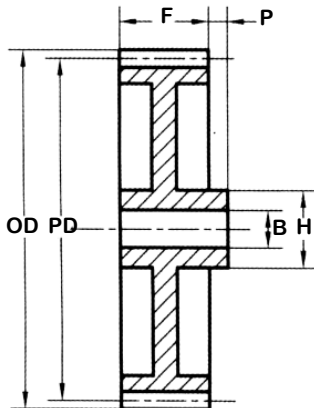

Type B1

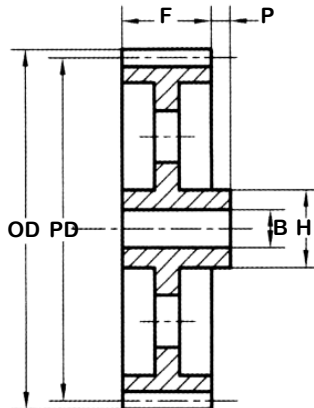

Type B2

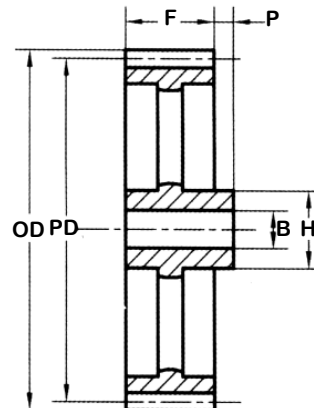

Type B3

3 DP - 3" Face

Part No.	Diameter		Type	Hubs			Weight (Lbs)
	OD	PD		H	F + P	B	
C340	14.000	13.333	B2	5 1/2	4 3/4	1 7/16	75.90
C342	14.666	14.000	B2	5 1/2	4 3/4	1 7/16	79.50
C344	15.333	14.666	B2	5 1/2	4 3/4	1 7/16	82.00
C348	16.666	16.000	B3	5 1/2	4 3/4	1 9/16	92.90
C354	18.666	18.000	B3	5 1/2	4 3/4	1 9/16	104.00
C356	19.333	18.666	B3	5 1/2	4 3/4	1 9/16	108.00
C360	20.666	20.000	B3	5 1/2	4 3/4	1 9/16	115.00
C364	22.000	21.333	B3	6	4 3/4	1 9/16	125.00
C372	24.666	24.000	B3	6	4 3/4	1 9/16	153.00
C380	27.333	26.666	B3	6	4 3/4	1 9/16	169.00
C384	28.666	28.000	B3	6	4 3/4	1 11/16	178.00
C388	30.000	29.333	B3	6	4 3/4	1 11/16	181.00
C396	32.666	32.000	B3	6	4 3/4	1 11/16	205.00
C3108	36.666	36.000	B3	6	4 3/4	1 11/16	228.00
C3120	40.000	40.666	B3	6 1/2	4 3/4	1 11/16	256.00

4 DP - 2" Face

Part No.	Diameter		Type	Hubs			Weight (Lbs)
	OD	PD		H	F + P	B	
C454	14.000	13.500	B3	4	3 1/2	1 1/4	44.70
C456	14.500	14.000	B3	4	3 1/2	1 1/4	46.70
C460	15.500	15.000	B3	4	3 1/2	1 1/4	49.50
C464	16.500	16.000	B3	4	3 1/2	1 1/4	54.50
C472	18.500	18.000	B3	4 1/2	3 1/2	1 1/4	63.00
C480	20.500	20.000	B3	4 1/2	3 1/2	1 3/8	72.00
C484	21.500	21.000	B3	4 1/2	3 1/2	1 3/8	73.00
C488	22.500	22.000	B3	4 1/2	3 3/4	1 3/8	75.00
C496	24.500	24.000	B3	4 1/2	3 3/4	1 3/8	86.00
C4108	27.500	27.000	B3	5	3 3/4	1 3/8	107.00
C4120	30.500	30.000	B3	5	3 3/4	1 3/8	115.00
C4144	19.250	36.000	B3	5 1/2	3 3/4	1 3/8	140.00

5 DP - 1 3/4" Face

Part No.	Diameter		Type	Hubs			Weight (Lbs)
	OD	PD		H	F + P	B	
C580	16.400	16.000	B3	4	3	1 3/16	40.80
C590	18.400	18.000	B3	4	3	1 3/16	45.40
C5100	20.400	20.000	B3	4 1/2	3 1/4	1 5/16	54.40
C5110	-	-	-	-	-	1 5/16	-
C5120	24.400	24.000	B3	4 3/4	3 1/4	1 5/16	56.10

6 DP - 1 1/2" Face

Part No.	Diameter		Type	Hubs			Weight (Lbs)
	OD	PD		H	F + P	B	
C658	10.000	9.666	B3	3 1/4	2 1/2	1 1/8	16.60
C660	10.333	10.000	B3	3 1/4	2 3/4	1 1/4	17.00
C664	11.000	10.666	B3	3 1/4	2 3/4	1 1/4	18.50
C666	11.333	11.000	B3	3 1/4	2 3/4	1 1/4	19.00
C672	12.333	12.000	B3	3 1/2	2 3/4	1 1/4	23.70
C684	14.333	14.000	B3	3 1/2	2 3/4	1 1/4	26.00
C696	16.333	16.000	B3	3 1/2	2 3/4	1 1/4	28.00
C6108	18.333	18.000	B3	3 3/4	2 3/4	1 1/4	32.00
C6120	20.333	20.000	B3	3 3/4	3	1 1/4	34.80
C6132	22.333	22.000	B3	3 3/4	3	1 1/4	43.40
C6144	24.333	24.000	B3	4	3	1 1/4	45.20

Sample Part:

C340

C = Cast Iron

3 = Diametral Pitch

40 = No. Teeth

Bored to Size Gears
Available in Standard ANSI
or Metric (ISO) Bores,
Keyways and (2) Setscrews

American Standard (ANSI) MPB Steel Spur Gears

Pressure Angle 20°

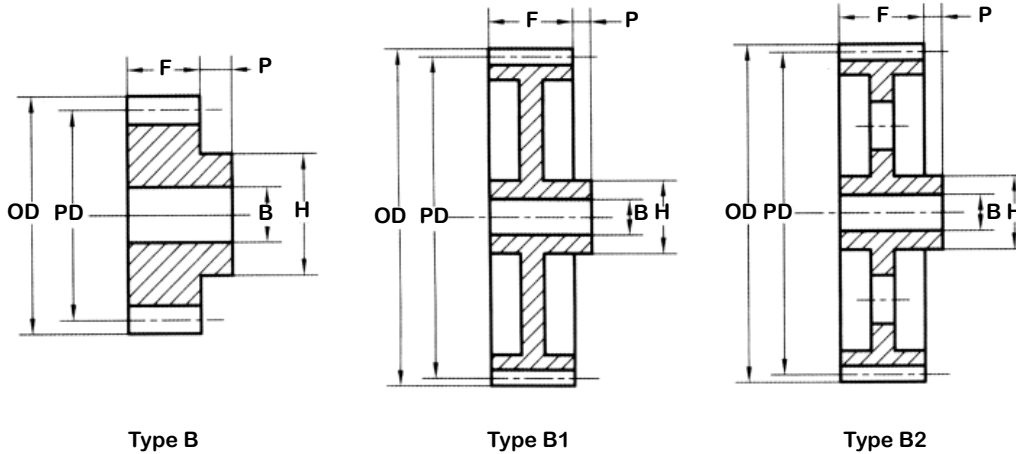

4 DP - 3 1/2" Face

Part No.	Diameter		Type	Hubs			Weight (Lbs)
	OD	PD		H	F + P	B	
20S412	3.500	3.000	B	2 17/64	4 3/8	1-1/8	6.8
20S414	4.000	3.500	B	2 49/64	4 3/8	1-1/8	9.8
20S415	4.250	3.750	B	3 1/64	4 3/8	1-1/8	11.5
20S416	4.500	4.000	B	3 17/64	4 3/8	1-1/8	13.3
20S418	5.000	4.500	B	3 49/64	4 3/8	1-1/8	17.3
20S420	5.500	5.000	B	4 17/64	4 3/8	1-1/8	21.8
20S422	6.000	5.500	B	4 49/64	4 3/8	1-1/8	26.7
20S424	6.500	6.000	B	5	4 3/4	1-1/8	33.7
20S428	7.500	7.000	B	5	4 3/4	1-1/8	43.8
20S430	8.000	7.500	B	5	4 3/4	1-1/8	49.4
20S432	8.500	8.000	B	5	5	1-1/4	56.8
20S435	9.250	8.750	B	5	5	1-1/4	65.1
20S436	9.500	9.000	B	5	5	1-1/4	70.0
20S440	10.500	10.000	B	5 1/8	5	1-1/4	85.2
20S444	11.500	11.000	B	5 1/8	5	1-1/4	101.6
20S445	11.750	11.250	B	5 1/8	5	1-1/4	108.7
20S448	12.500	12.000	B	5 1/8	5	1-1/4	119.5
20S450	13.000	12.500	B	5 1/8	5	1-1/4	125.6
20S456	14.500	14.000	B1	5 1/2	5	1-1/4	96.9
20S460	15.500	15.000	B1	5 1/2	5	1-1/4	88.1
20S464	16.500	16.000	B1	5 1/2	5	1-1/4	86.9

5 DP - 2 1/2" Face

Part No.	Diameter		Type	Hubs			Weight (Lbs)
	OD	PD		H	F + P	B	
20S512	2.80	2.40	B	1 25/32	3 3/8	1-1/8	2.9
20S514	3.20	2.80	B	2 3/16	3 3/8	1-1/8	4.3
20S515	3.40	3.00	B	2 3/8	3 3/8	1-1/8	5.2
20S516	3.60	3.20	B	2 19/32	3 3/8	1-1/8	6.1
20S518	4.00	3.60	B	3	3 3/8	1-1/8	8.0
20S520	4.40	4.00	B	3 3/8	3 3/8	1-1/8	10.2
20S522	4.80	4.40	B	3 3/4	3 3/4	1-1/8	13.8
20S524	5.20	4.80	B	3 3/4	3 3/4	1-1/8	15.7
20S525	5.40	5.00	B	3 3/4	3 3/4	1-1/8	20.3
20S528	6.00	5.60	B	3 3/4	3 3/4	1-1/8	22.9
20S530	6.40	6.00	B	3 3/4	3 3/4	1-1/8	23.9
20S532	6.80	6.40	B	3 3/4	3 3/4	1-1/8	25.6
20S535	7.40	7.00	B	3 3/4	3 3/4	1-1/4	29.9
20S536	7.60	7.20	B	3 3/4	3 3/4	1-1/4	35.
20S540	8.40	8.00	B	3 3/4	3 3/4	1-1/4	38.2
20S544	9.20	8.80	B	3 3/4	3 3/4	1-1/4	43.5
20S545	9.40	9.00	B	3 3/4	3 3/4	1-1/4	47.7
20S548	10.00	9.60	B	3 3/4	3 3/4	1-1/4	55.1
20S550	10.40	10.00	B	4 5/8	3 3/4	1-1/4	60.3
20S556	11.60	11.20	B	4 5/8	3 3/4	1-1/4	75.8
20S560	12.40	12.00	B	4 5/8	3 3/4	1-1/4	84.7

Sample Part:

20S412

20 = Degrees Pressure Angle

S = Steel

4 = Diametral Pitch

12 = No. Teeth

Bored to Size Gears
Available in Standard ANSI
or Metric (ISO) Bores,
Keyways and (2) Setscrews



American Metric® Corporation

GROUP: 125

1-125-120803

American Standard (ANSI) MPB Steel Spur Gears Pressure Angle 20°

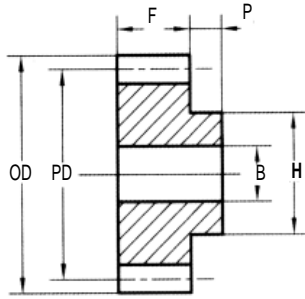

Type B

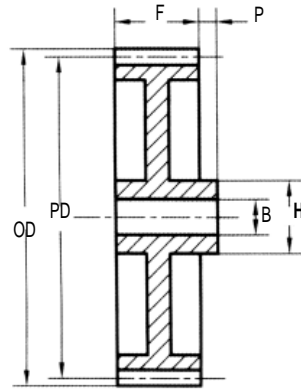

Type B2

6 DP - 2" Face

Part No.	Diameter		Type	Hubs			Weight (Lbs)
	OD	PD		H	F + P	B	
20S611	2.333	2.000	B	1 1/2	2 7/8	1	1.6
20S612	2.333	2.000	B	1 1/2	2 7/8	1	1.6
20S614	2.666	2.333	B	1 13/16	2 7/8	1	2.4
20S615	2.833	2.500	B	2	2 7/8	1	2.9
20S616	3.000	2.666	B	2 1/8	2 7/8	1	3.4
20S618	3.333	3.000	B	2 1/2	2 7/8	1	4.6
20S619	3.500	3.167	B	2 5/8	2 7/8	1	5.1
20S620	3.666	3.333	B	2 3/4	2 7/8	1	5.9
20S621	3.833	3.500	B	3	2 7/8	1	6.6
20S622	4.000	3.666	B	3	2 7/8	1	7.5
20S624	4.333	4.000	B	3	2 7/8	1-1/8	8.1
20S626	4.666	4.333	B	3 1/2	2 7/8	1-1/8	9.5
20S627	4.833	4.500	B	3 1/2	2 7/8	1-1/8	10.6
20S628	5.000	4.666	B	3 1/2	2 7/8	1-1/8	12.0
20S630	5.333	5.000	B	4	2 7/8	1-1/8	13.4
20S632	5.666	5.333	B	4	2 7/8	1-1/8	15.5
20S633	5.833	5.500	B	4	3 1/2	1-1/8	17.8
20S636	6.333	6.000	B	4	3 1/2	1-1/8	20.4
20S640	7.000	6.666	B	4	3 1/2	1-1/8	22.5
20S642	7.333	7.000	B	4	3 1/2	1-1/8	26.2
20S644	7.666	7.333	B	4	3 1/2	1-1/8	29.5
20S648	8.333	8.000	B	4	3 1/2	1-1/8	32.8
20S654	9.333	9.000	B	4	3 1/2	1-1/8	40.4
20S660	10.333	10.000	B	4 5/8	3 1/2	1-1/4	50.0
20S664	11.000	10.666	B	4 5/8	3 1/2	1-1/4	56.5
20S672	12.333	12.000	B	4 5/8	3 1/2	1-1/4	70.0

8 DP - 1 1/2" Face

Part No.	Diameter		Type	Hubs			Weight (Lbs)
	OD	PD		H	F + P	B	
20S811	1.750	1.500	B	1 1/16	2 1/4	3/4	0.7
20S812	1.750	1.500	B	1 1/8	2 1/4	3/4	1.2
20S814	2.000	1.750	B	1 5/16	2 1/4	3/4	1.2
20S815	2.125	1.875	B	1 7/16	2 1/4	3/4	1.4
20S816	2.250	2.000	B	1 9/16	2 3/8	7/8	1.9
20S818	2.500	2.250	B	1 13/16	2 3/8	7/8	2.3
20S819	2.626	2.375	B	2	2 3/8	7/8	2.5
20S820	2.750	2.500	B	2 1/16	2 3/8	7/8	3.2
20S821	2.875	2.625	B	2 5/16	2 3/8	7/8	3.6
20S822	3.000	2.750	B	2 7/16	2 3/8	7/8	3.9
20S824	3.250	3.000	B	2 9/16	2 3/8	7/8	4.6
20S826	3.500	3.250	B	2 3/4	2 3/8	7/8	5.2
20S827	3.625	3.375	B	2 3/4	2 3/8	7/8	5.4
20S828	3.750	3.500	B	2 3/4	2 3/8	7/8	5.6
20S830	4.000	3.750	B	-	2 3/8	1	6.6
20S832	4.250	4.000	B	3 1/4	2 3/8	1	8.6
20S833	4.375	4.125	B	3 1/2	2 3/8	1	9.4
20S836	4.750	4.500	B	3 1/2	2 3/8	1	10.2
20S840	5.250	5.000	B	3 1/2	2 3/8	1	11.4
20S842	5.500	5.250	B	3 1/2	2 1/2	1	12.3
20S844	5.750	5.500	B	3 1/2	2 1/2	1	13.5
20S848	6.250	6.000	B	3 1/2	2 1/2	1	14.2

Sample Part:

20S611

20 = Degrees Pressure Angle

S = Steel

6 = Diametral Pitch

11 = No. Teeth

Bored to Size Gears
Available in Standard ANSI
or Metric (ISO) Bores,
Keyways and (2) Setscrews

American Standard (ANSI) MPB Steel Spur Gears

Pressure Angle 20°

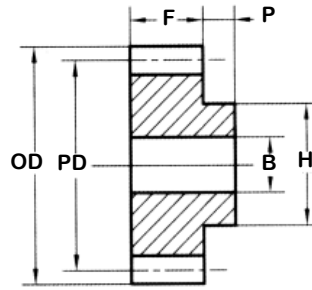

Type B

10 DP - 1 1/4" Face

Part No.	Diameter		Type	Hubs			Weight (Lbs)
	OD	PD		H	F + P	B	
20S1012	1.40	1.20	B	29/32	1 7/8	5/8	0.40
20S1013	1.50	1.30	B	1	1 7/8	5/8	0.50
20S1014	1.60	1.40	B	1 7/64	1 7/8	3/4	0.60
20S1015	1.70	1.50	B	1 7/32	1 7/8	3/4	0.70
20S1016	1.80	1.60	B	1 5/16	1 7/8	3/4	0.80
20S1018	2.00	1.80	B	1 11/32	1 7/8	3/4	0.90
20S1019	2.10	1.90	B	1 9/16	1 7/8	3/4	1.10
20S1020	2.20	2.00	B	1 39/64	1 7/8	7/8	1.20
20S1021	2.30	2.10	B	1 3/4	1 7/8	7/8	1.30
20S1022	2.40	2.20	B	1 13/16	1 7/8	7/8	1.50
20S1024	2.60	2.40	B	2 1/64	1 7/8	7/8	1.80
20S1025	2.70	2.50	B	2 7/64	1 7/8	7/8	2.00
20S1026	2.80	2.60	B	2 1/8	1 7/8	7/8	2.20
20S1028	3.00	2.80	B	2 13/32	1 7/8	7/8	2.70
20S1030	3.20	3.00	B	2 1/2	1 7/8	7/8	3.40
20S1032	3.40	3.20	B	2 1/2	2 1/8	7/8	3.70
20S1035	3.70	3.50	B	2 1/2	2 1/8	1	4.20
20S1036	3.80	3.60	B	2 1/2	2 1/8	1	4.30
20S1040	4.20	4.00	B	3 1/2	2 1/8	1	6.40
20S1042	4.40	4.20	B	3 1/2	2 1/8	1	6.90
20S1045	4.70	4.50	B	3 1/2	2 1/8	1	7.50
20S1048	5.00	4.80	B	3 3/4	2 1/8	1	8.70
20S1050	5.20	5.00	B	4	2 1/8	1	9.90
20S1054	5.60	5.40	B	4	2 1/4	1	10.80
20S1055	5.70	5.50	B	4	2 1/4	1	11.50
20S1060	6.20	6.00	B	4	2 1/4	1	13.1

12 DP - 1" Face

Part No.	Diameter		Type	Hubs			Weight (Lbs)
	OD	PD		H	F + P	B	
20S1212	1.167	1.000	B	3/4	1 5/8	1/2	0.21
20S1213	1.250	1.083	B	13/16	1 5/8	5/8	0.21
20S1214	1.333	1.167	B	29/32	1 5/8	5/8	0.28
20S1215	1.417	1.250	B	63/64	1 5/8	5/8	0.34
20S1216	1.500	1.333	B	1 1/16	1 5/8	5/8	0.41
20S1218	1.667	1.500	B	1 1/4	1 5/8	3/4	0.51
20S1219	1.750	1.583	B	1 5/16	1 5/8	3/4	0.59
20S1220	1.833	1.667	B	1 5/16	1 5/8	3/4	0.65
20S1221	1.917	1.750	B	1 25/64	1 5/8	3/4	0.75
20S1222	2.000	1.833	B	1 9/16	1 5/8	3/4	0.88
20S1224	2.166	2.000	B	1 41/64	1 5/8	3/4	1.06
20S1225	2.250	2.083	B	1 13/16	1 5/8	3/4	1.22
20S1226	2.333	2.167	B	1 7/8	1 5/8	3/4	1.33
20S1228	2.500	2.333	B	2 1/16	1 5/8	3/4	1.60
20S1230	2.667	2.500	B	2 5/32	1 5/8	3/4	1.83
20S1232	2.833	2.667	B	2 1/4	1 5/8	3/4	2.08
20S1235	3.084	2.917	B	2 1/4	1 5/8	3/4	2.50
20S1236	3.167	3.000	B	2 1/2	1 7/8	3/4	2.98
20S1240	3.500	3.333	B	2 1/2	1 7/8	3/4	3.25
20S1242	3.666	3.500	B	2 1/2	1 7/8	7/8	3.71
20S1245	3.917	3.750	B	2 1/2	1 7/8	7/8	4.50
20S1248	4.166	4.000	B	3	1 7/8	7/8	4.99
20S1250	4.333	4.166	B	3 1/2	1 7/8	7/8	5.80
20S1254	4.666	4.500	B	3 1/2	1 7/8	7/8	6.51
20S1255	4.750	4.583	B	3 1/2	1 7/8	7/8	7.25
20S1260	5.166	5.000	B	3 1/2	1 7/8	7/8	7.63
20S1266	5.666	5.500	B	3 1/2	1 7/8	7/8	8.80
20S1272	6.166	6.000	B	3 1/2	1 7/8	7/8	10.08

Sample Part:

20S1012

20 = Degrees Pressure Angle

S = Steel

10 = Diametral Pitch

12 = No. Teeth

Bored to Size Gears
Available in Standard ANSI
or Metric (ISO) Bores,
Keyways and (2) Setscrews

American Standard (ANSI) MPB Steel Spur Gears Pressure Angle 20°

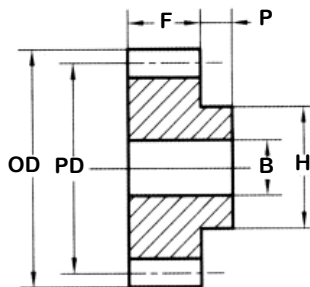

Type B

16 DP - 3/4" Face

Part No.	Diameter		Type	Hubs			Weight (Lbs)
	OD	PD		H	F + P	B	
20S1612	0.875	0.750	B	9/16	1 1/4	3/8	0.09
20S1613	0.938	0.812	B	5/8	1 1/4	3/8	0.11
20S1614	1.000	0.875	B	11/16	1 1/4	3/8	0.14
20S1615	1.063	0.937	B	3/4	1 1/4	3/8	0.17
20S1616	1.125	1.000	B	13/16	1 1/4	1/2	0.17
20S1617	1.188	1.062	B	7/8	1 1/4	1/2	0.20
20S1618	1.250	1.125	B	15/16	1 1/4	1/2	0.24
20S1620	1.375	1.250	B	1 1/16	1 1/4	5/8	0.28
20S1621	1.438	1.312	B	1 1/8	1 1/4	5/8	0.32
20S1622	1.500	1.375	B	1 3/16	1 1/4	5/8	0.36
20S1624	1.625	1.500	B	1 5/16	1 1/4	5/8	0.46
20S1625	1.688	1.562	B	1 3/8	1 1/4	5/8	0.48
20S1626	1.750	1.625	B	1 7/16	1 1/4	5/8	0.56
20S1628	1.875	1.750	B	1 1/2	1 1/4	5/8	0.65
20S1630	2.000	1.875	B	1 5/8	1 1/4	5/8	0.77
20S1632	2.125	2.000	B	1 3/4	1 1/4	5/8	0.90
20S1635	2.312	2.187	B	2	1 1/4	5/8	1.10
20S1636	2.375	2.250	B	2	1 1/4	5/8	1.18
20S1640	2.625	2.500	B	2	1 3/8	5/8	1.48
20S1645	2.937	2.812	B	2	1 3/8	5/8	1.80
20S1648	3.125	3.000	B	2	1 3/8	5/8	1.94
20S1650	3.250	3.125	B	2	1 3/8	5/8	2.25
20S1656	3.625	3.500	B	2 1/2	1 3/8	5/8	2.79
20S1660	3.875	3.750	B	2 3/4	1 3/8	5/8	3.28
20S1664	4.125	4.000	B	2 3/4	1 1/2	3/4	3.74
20S1670	4.500	4.375	B	3	1 1/2	3/4	4.31
20S1672	4.625	4.500	B	3	1 1/2	3/4	4.64
20S1680	5.125	5.000	B	3 1/2	1 1/2	3/4	6.03
20S1684	5.375	5.250	B	3 1/2	1 1/2	3/4	6.46
20S1690	5.750	5.625	B	3 1/2	1 1/2	3/4	7.35
20S1695	6.125	6.000	B	3 1/2	1 1/2	3/4	7.86
20S16100	6.375	6.250	B	3 1/2	1 1/2	3/4	8.50
20S16104	6.250	6.500	B	3 1/2	1 1/2	3/4	8.91

20 DP - 1/2" Face

Part No.	Diameter		Type	Hubs			Weight (Lbs)
	OD	PD		H	F + P	B	
20S2012	0.700	0.600	B	15/32	15/16	5/16	0.04
20S2013	0.750	0.650	B	1/2	15/16	5/16	0.05
20S2014	0.800	0.700	B	35/64	15/16	5/16	0.06
20S2015	0.850	0.750	B	39/64	15/16	3/8	0.07
20S2016	0.900	0.800	B	21/32	15/16	3/8	0.08
20S2017	0.950	0.850	B	3/4	15/16	3/8	0.10
20S2018	1.000	0.900	B	3/4	15/16	3/8	0.12
20S2020	1.100	1.000	B	55/64	15/16	1/2	0.13
20S2021	1.150	1.05	B	7/8	15/16	1/2	0.15
20S2022	1.200	1.100	B	31/32	15/16	1/2	0.17
20S2024	1.300	1.200	B	1 1/16	15/16	1/2	0.22
20S2025	1.350	1.250	B	1 7/64	15/16	1/2	0.24
20S2026	1.400	1.300	B	1 3/16	15/16	1/2	0.28
20S2028	1.500	1.400	B	1 17/64	15/16	1/2	0.32
20S2030	1.600	1.500	B	1 23/64	15/16	1/2	0.38
20S2032	1.700	1.600	B	1 7/16	1	1/2	0.46
20S2035	1.850	1.750	B	1 9/16	1	1/2	0.56
20S2036	1.900	1.800	B	1 5/8	1	1/2	0.60
20S2040	2.100	2.000	B	1 13/16	1	1/2	0.76
20S2045	2.350	2.250	B	2	1	1/2	0.95
20S2048	2.500	2.400	B	2	1	1/2	1.08
20S2050	2.600	2.500	B	2	1	1/2	1.45
20S2056	2.900	2.800	B	2	1	1/2	1.68
20S2060	3.100	3.000	B	2 1/8	1	1/2	1.93
20S2064	3.300	3.200	B	2 1/8	1	1/2	1.96
20S2070	3.600	3.500	B	2 3/8	1	1/2	2.01
20S2072	3.700	3.600	B	2 3/8	1	1/2	2.35
20S2080	4.100	4.000	B	2 1/2	1 1/8	5/8	2.53
20S2084	4.300	4.200	B	2 1/2	1 1/8	5/8	2.82
20S2090	4.600	4.500	B	2 1/2	1 1/8	5/8	2.95
20S2095	4.900	4.800	B	2 1/2	1 1/8	5/8	3.10
20S20100	5.100	5.000	B	2 1/2	1 1/8	5/8	3.35
20S20104	5.300	5.200	B	2 1/2	1 1/8	5/8	3.95

Sample Part:

20S1660

20 = Degrees Pressure Angle

S = Steel

16 = Diametral Pitch

60 = No. Teeth

Bored to Size Gears
Available in Standard ANSI
or Metric (ISO) Bores,
Keyways and (2) Setscrews



American Standard (ANSI) MPB Cast Iron Spur Gears Pressure Angle 20°

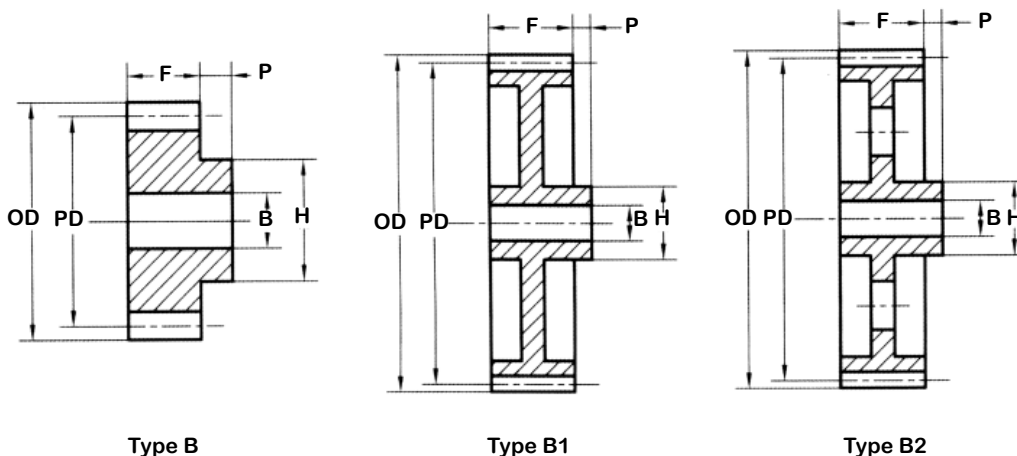

4 DP - 3 1/2" Face

Part No.	Diameter		Type	Hubs			Weight (Lbs)
	OD	PD		H	F + P	B	
20C456	14.500	14.000	B1	5 1/2	5	1-1/4	96.9
20C460	15.500	15.000	B2	5 1/2	5	1-1/4	88.1
20C464	16.500	16.000	B2	5 1/2	5	1-1/4	86.9
20C470	18.000	17.500	B2	5 1/2	5	1-1/4	86.4
20C472	18.500	18.000	B2	5 1/2	5	1-1/4	86.5
20C480	20.500	20.000	B2	5 1/2	5	1-1/4	90.9

5 DP - 2 1/2" Face

Part No.	Diameter		Type	Hubs			Weight (Lbs)
	OD	PD		H	F + P	B	
20C564	13.20	12.80	B2	5	3 3/4	1-1/4	49.8
20C570	14.40	14.00	B2	5	3 3/4	1-3/16	51.6
20C572	14.80	14.40	B2	5	3 3/4	1-3/16	53.7
20C580	16.40	16.00	B2	5	3 3/4	1-3/16	55.8
20C590	18.40	18.00	B2	5	3 3/4	1-3/16	59.7
20C5100	20.40	20.00	B2	5 1/2	4	1-5/16	69.2
20C5110	22.40	22.00	B2	5 1/2	4	1-5/16	72.3
20C5120	24.40	24.00	B2	6	4	1-5/16	80.2

6 DP - 2" Face

Part	Diameter		Type	Hubs			Weight (Lbs)
	OD	PD		H	F + P	B	
20C684	14.333	14.000	B2	5	3 1/2	1-1/4	42.8
20C696	16.333	16.000	B2	5	3 1/2	1-1/4	46.0
20C6108	18.333	18.000	B2	5	3 1/2	1-1/4	48.8
20C6120	20.333	20.000	B2	5	3 1/2	1-1/4	51.3

Sample Part:

20C456

20 = Degrees Pressure Angle

C = Cast Iron

4 = Diametral Pitch

56 = No. Teeth

Bored to Size Gears
Available in Standard ANSI
or Metric (ISO) Bores,
Keyways and (2) Setscrews